

Data Sheet



Article number: 586350213

Description: Ball Valve 350.213, G 1 1/4" - G 1 1/4"
Thread/Thread

Measures

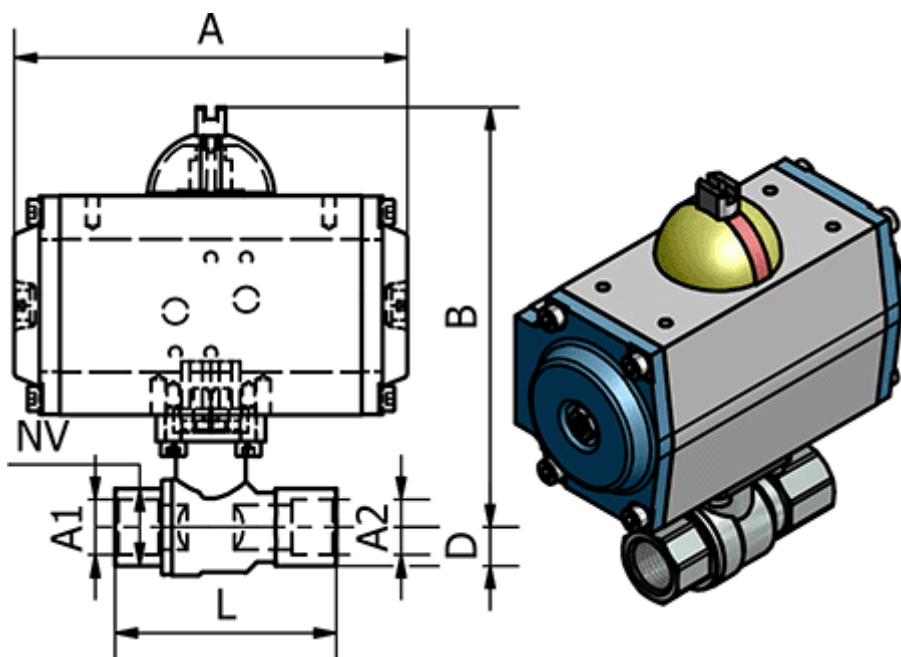

A	= 116
B	= 150
Connecting A1	= G 1 1/4"
Connecting A2	= G 1 1/4"
D	= 30
L	= 110
Max. Operating Pressure	= 40 bar
NV	= 50